

Hen

Question answered on page 32

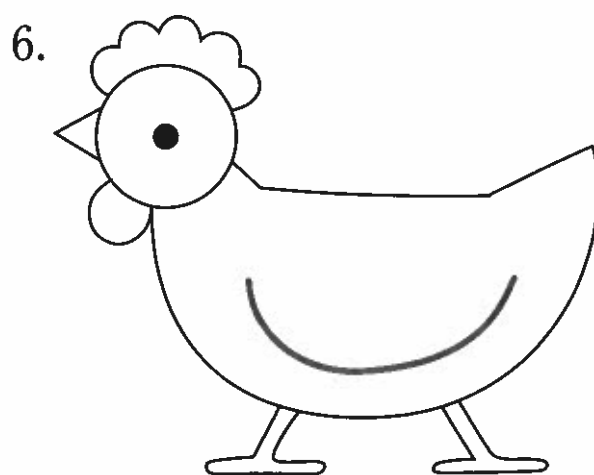
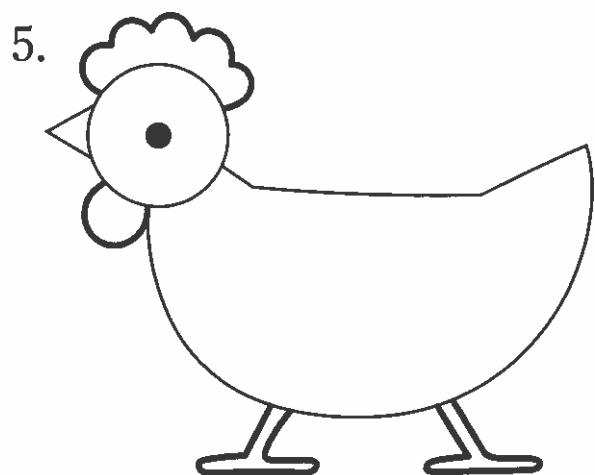
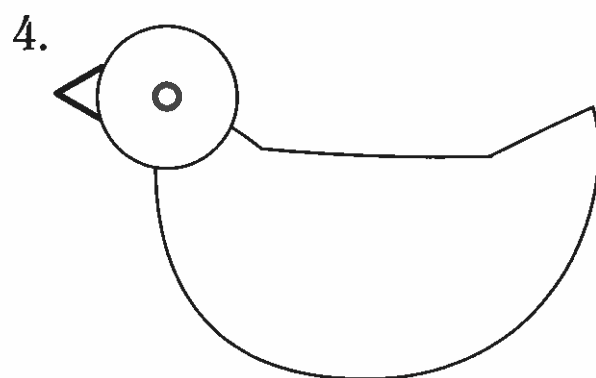
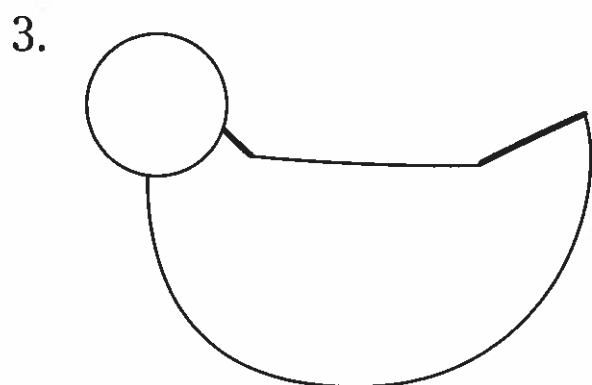
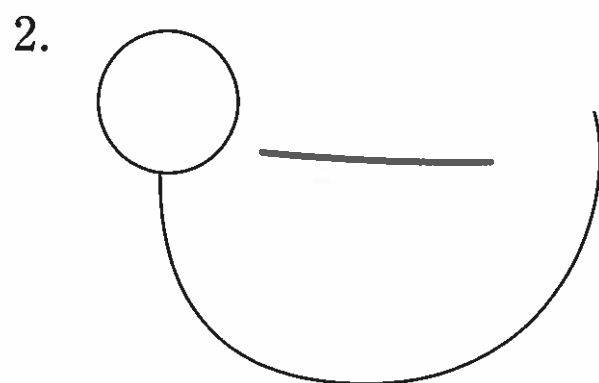
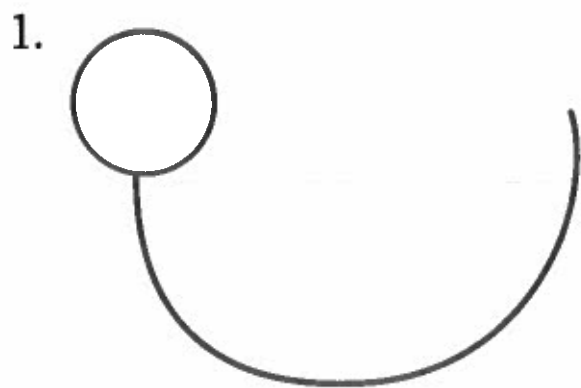

Pig

Teaching Tip on page 64
Question answered on page 32

1.

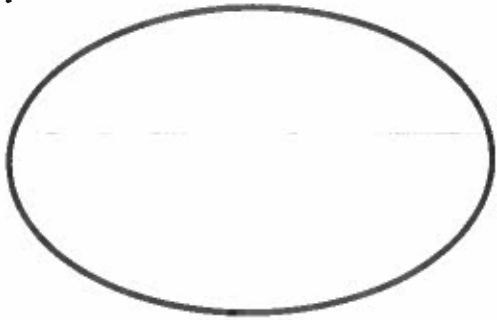

2.

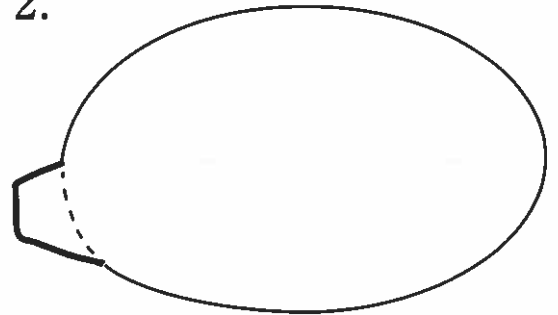

3.

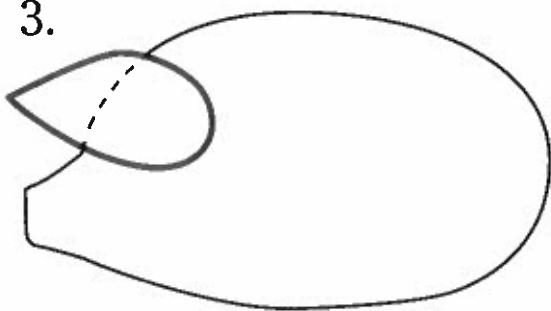

4.

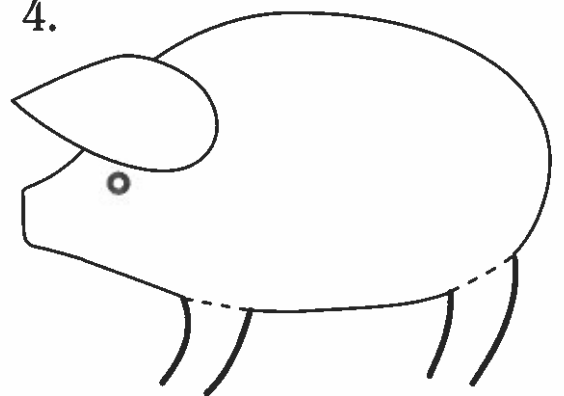

5.

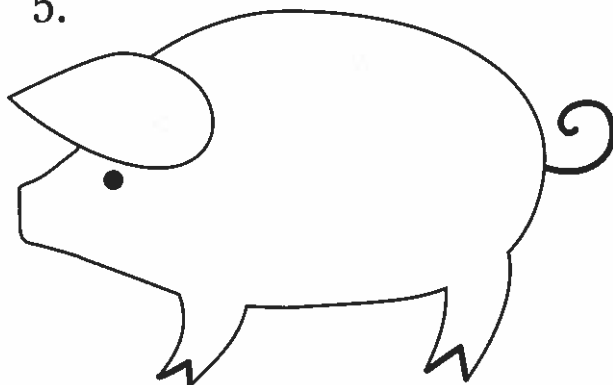

6.

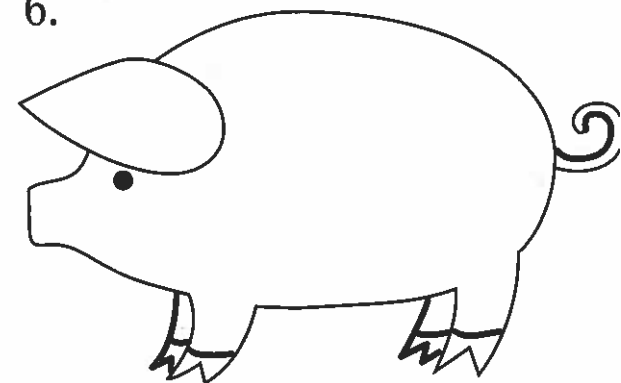

Sheep

*Teaching Tip on page 64
Question answered on page 32*

1.

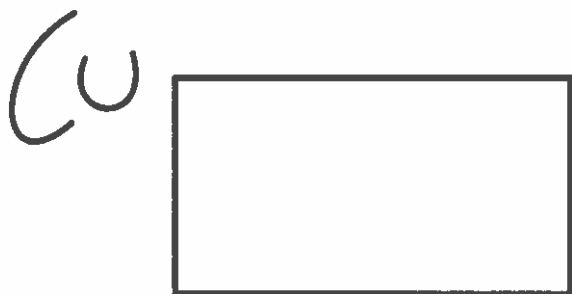

2.

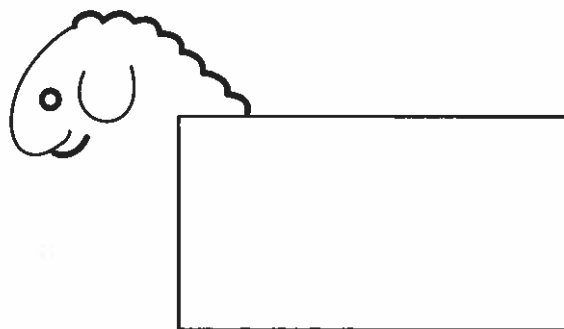

3.

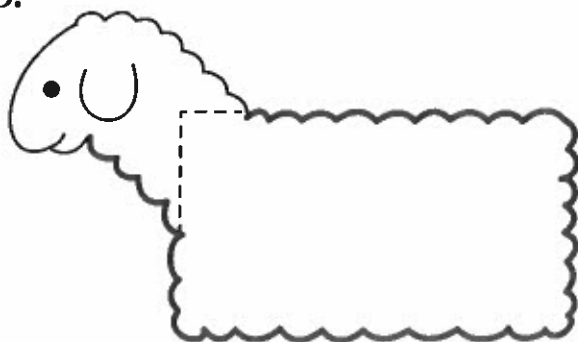

4.

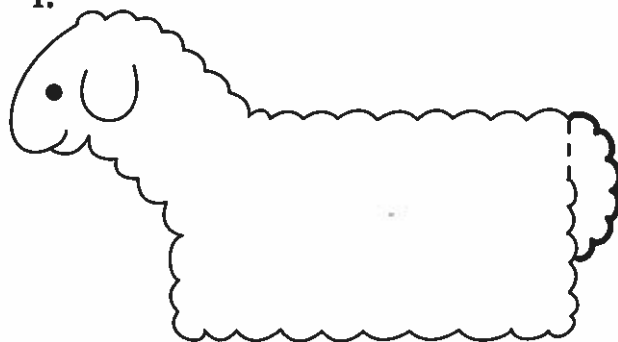

5.

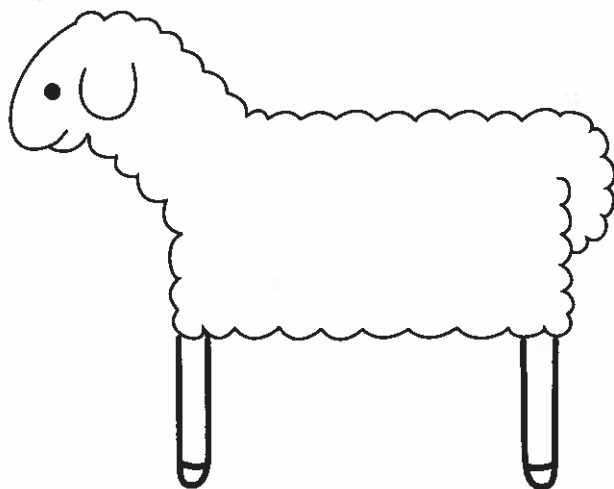

6.

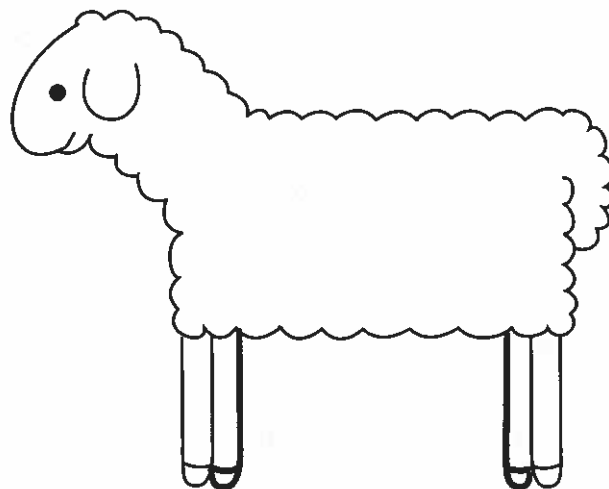

Cow

Teaching Tip on page 64
Question answered on page 32

1.



2.

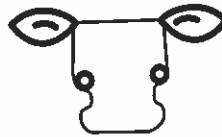

3.

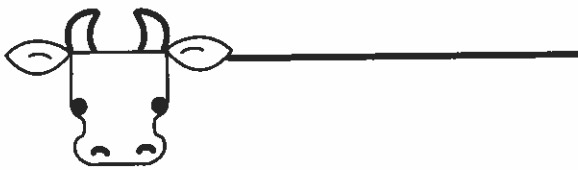

4.

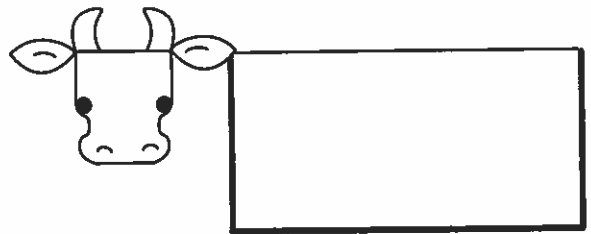

5.

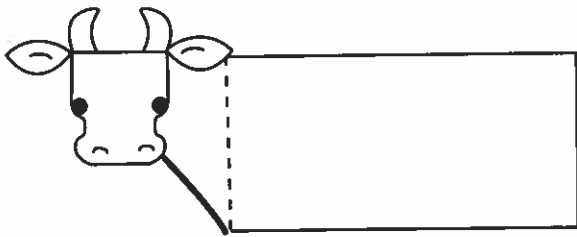

6.

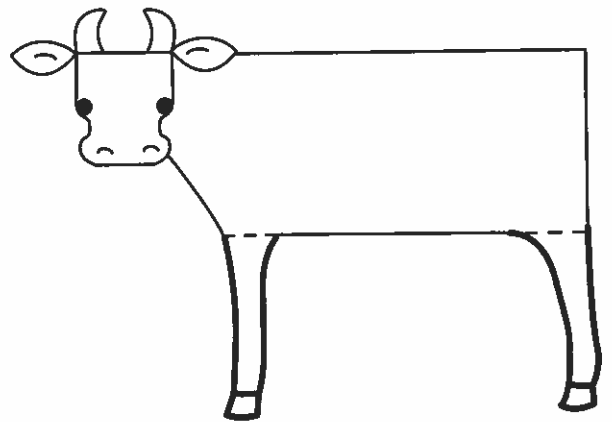

7.

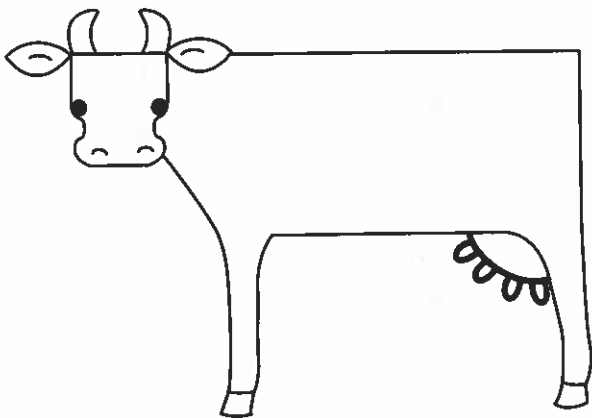

8.

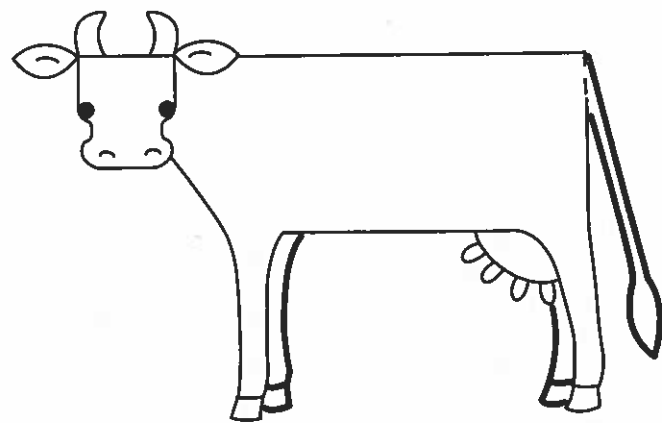

Horse

Teaching Tip on page 64
Question answered on page 32

1.



2.



3.



4.



5.

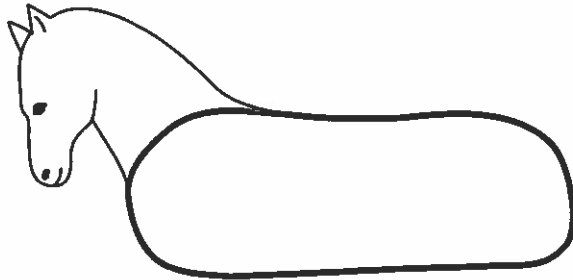

6.

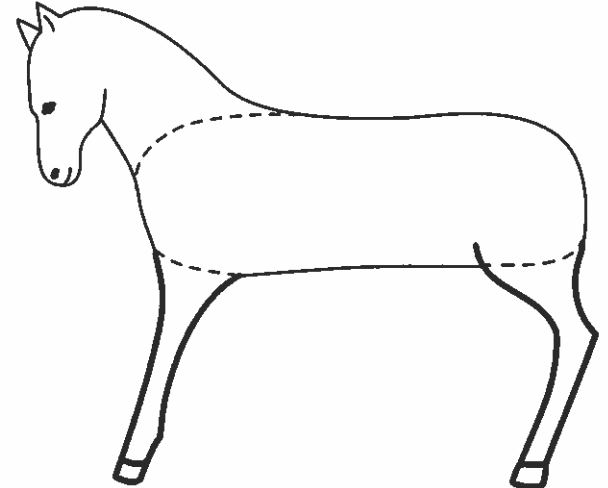

7.

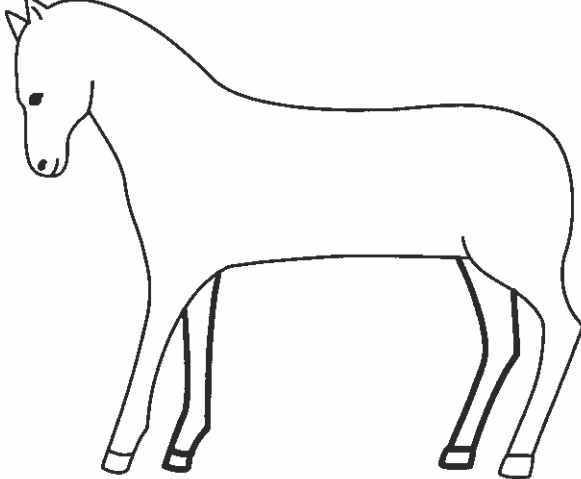

8.

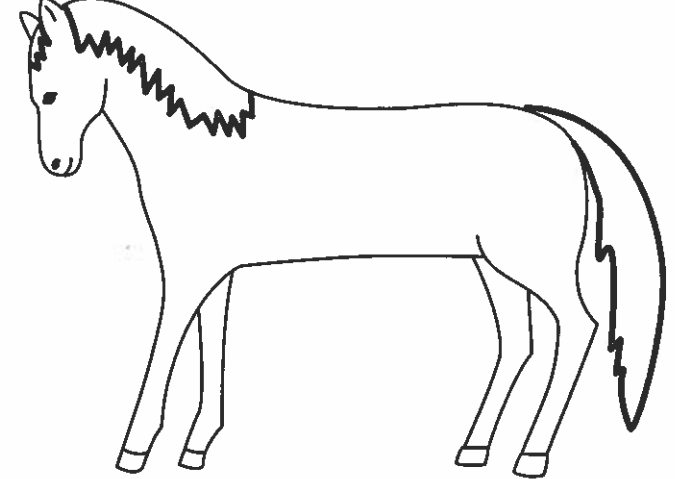

Turkey

1.

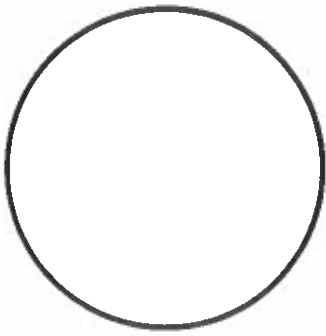

2.

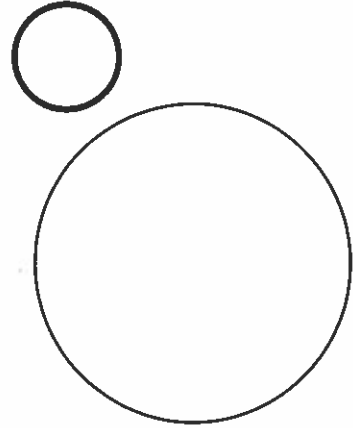

3.

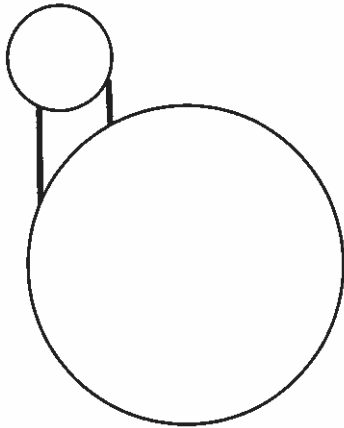

4.

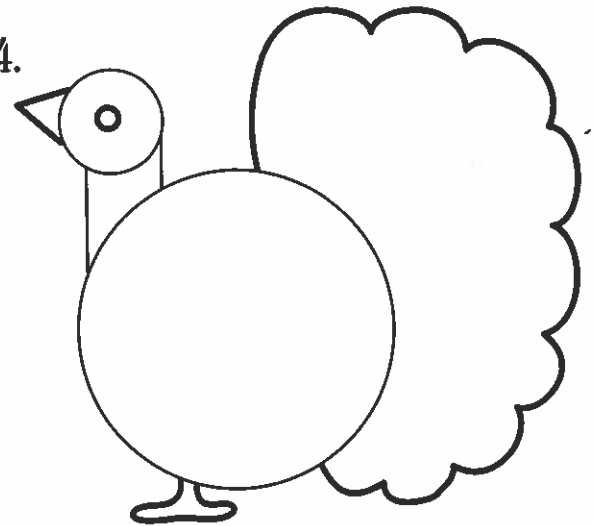

5.

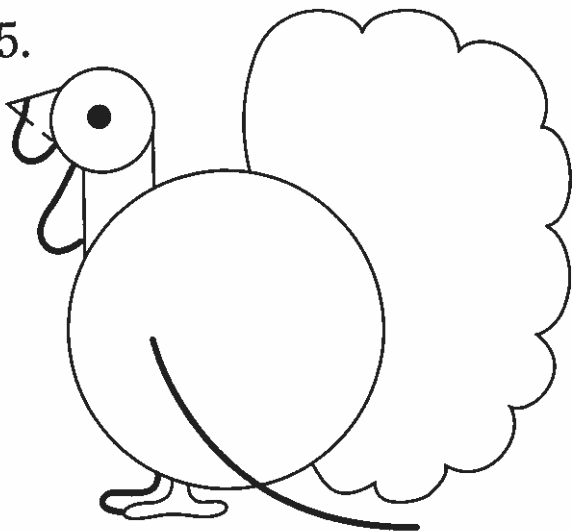

6.

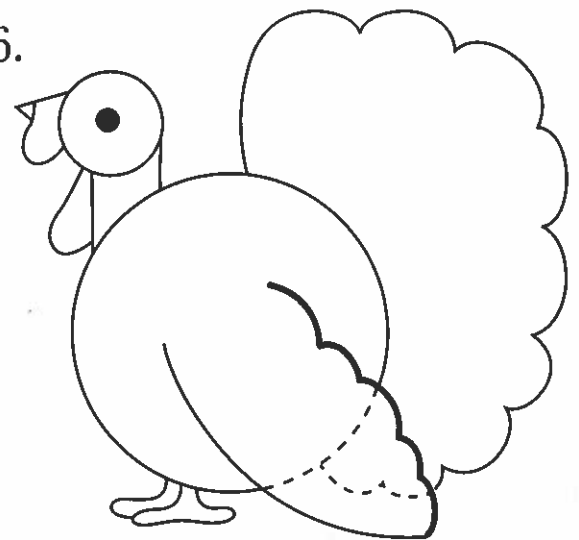

Barn

Teaching Tip on page 64
Question answered on page 32

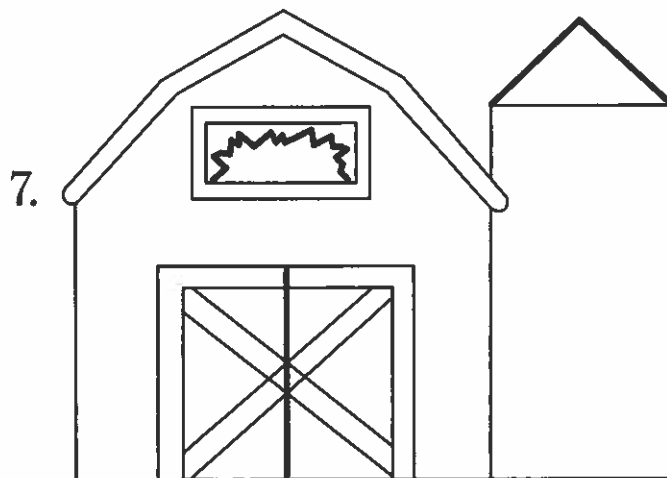
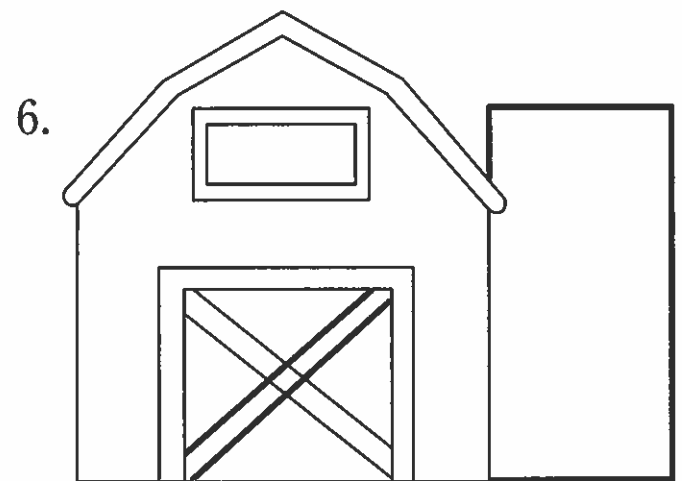
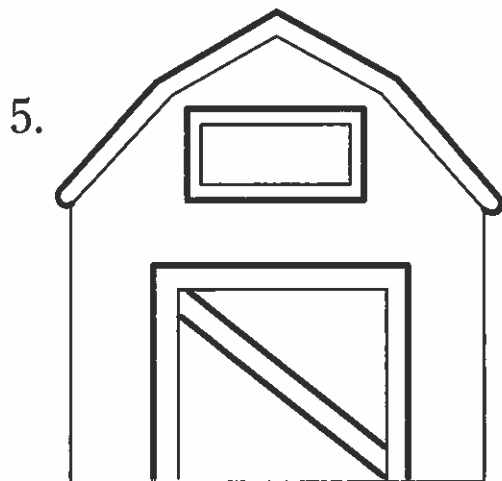
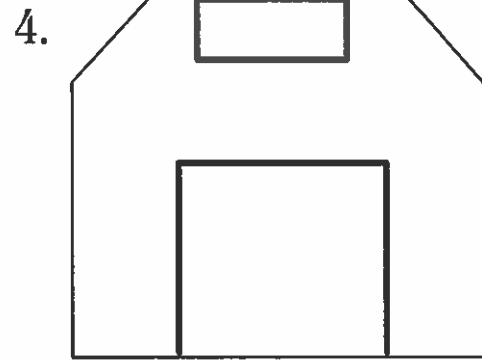
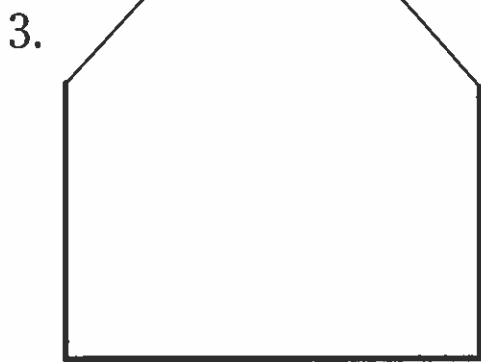
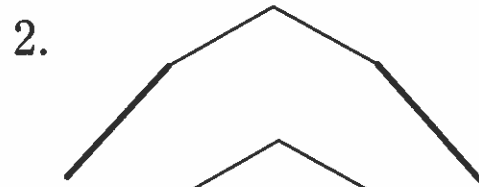

Duck

Teaching Tip on page 64
Question answered on page 32

1.

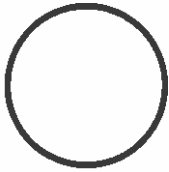

2.

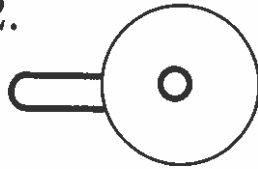

3.

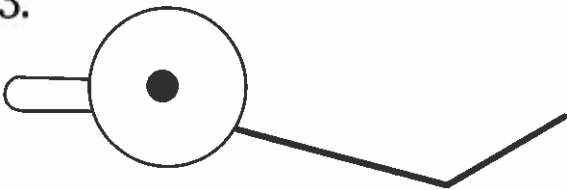

4.

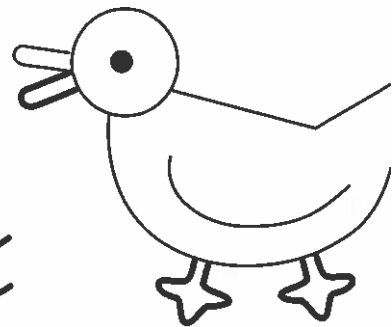
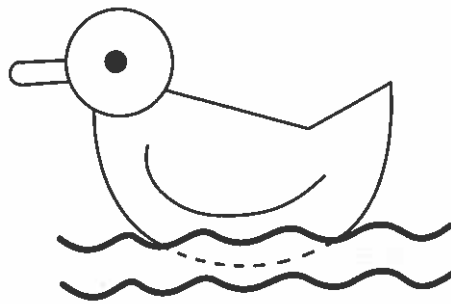
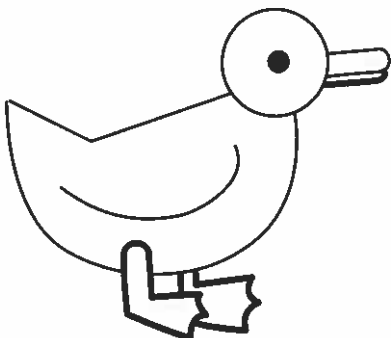
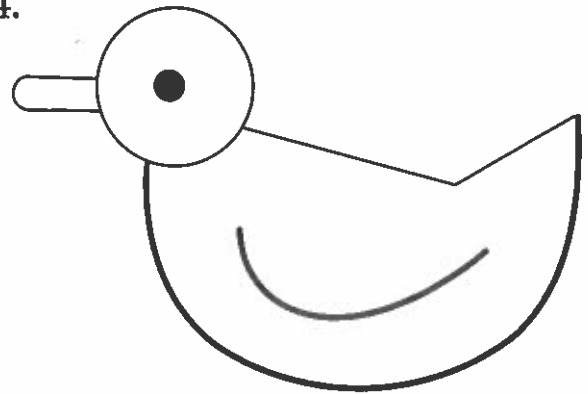

Goose

Question answered on page 32

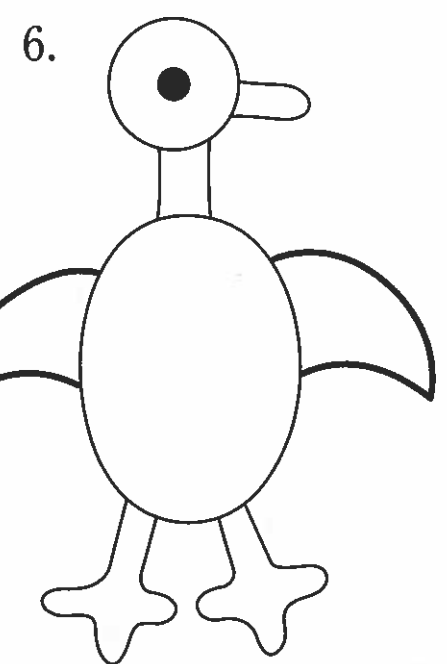
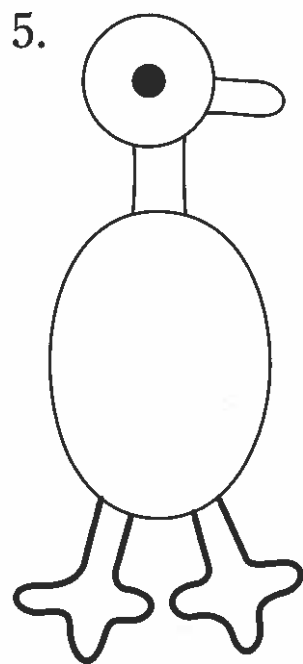
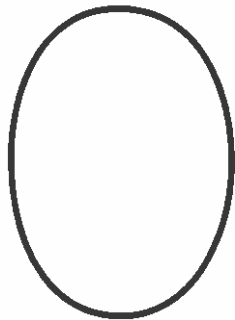
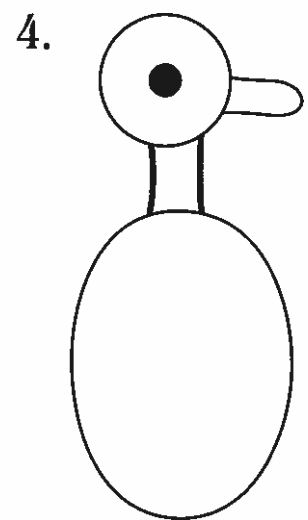
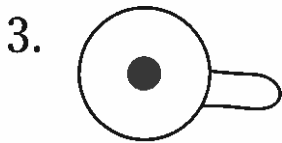
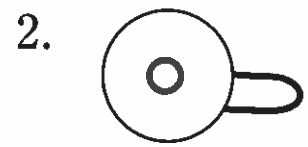

Tractor

Teaching Tip on page 64
Question answered on page 32

1.

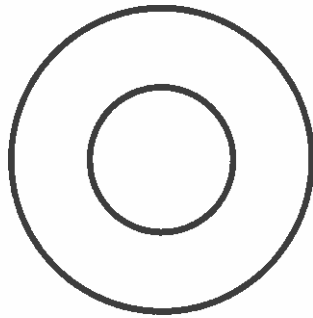

2.

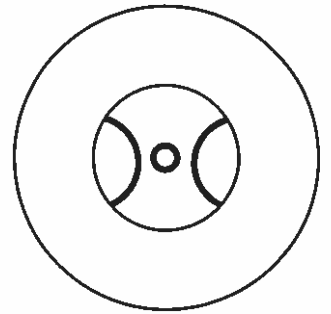

3.

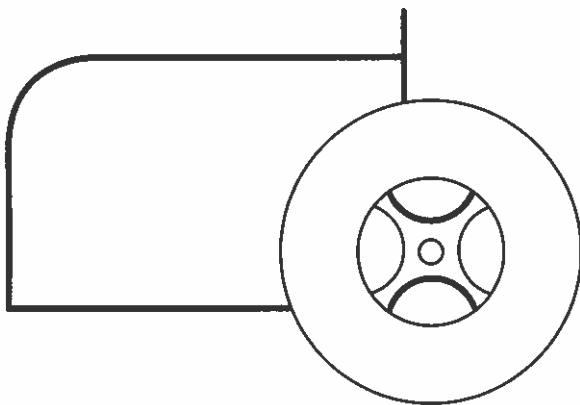

4.

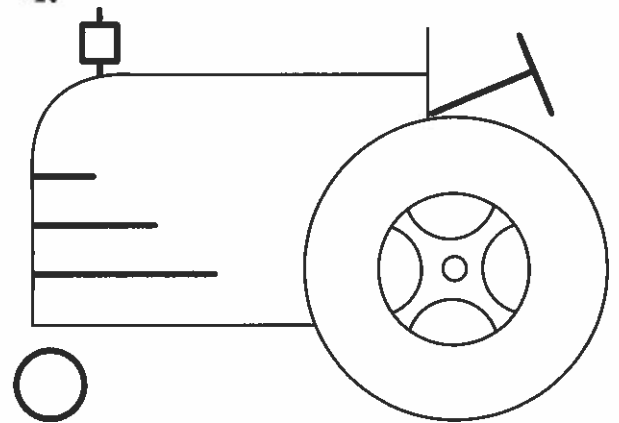

5.

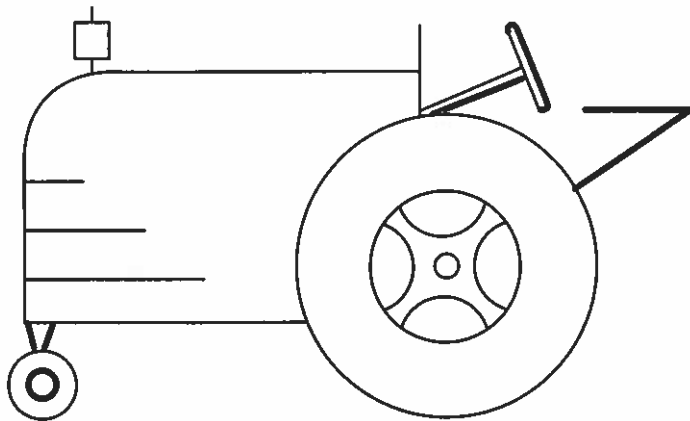

6.

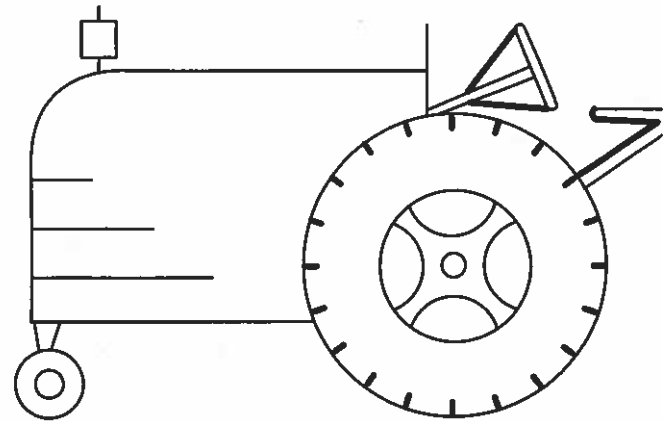

Girl

Teaching Tip on page 64
Question answered on page 50

1. girl

2. 

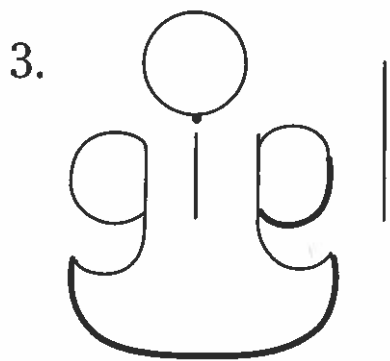
3. 

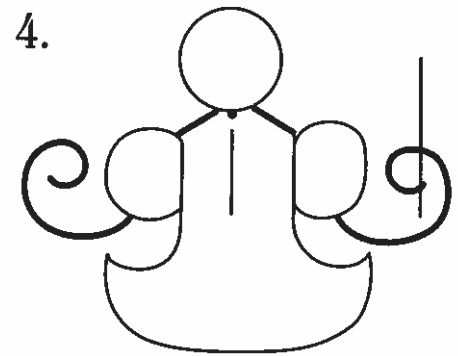
4. 

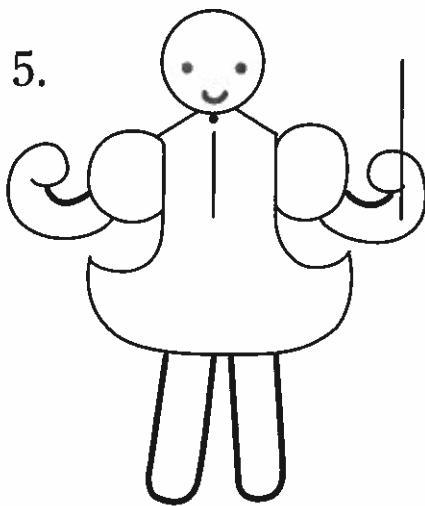
5. 

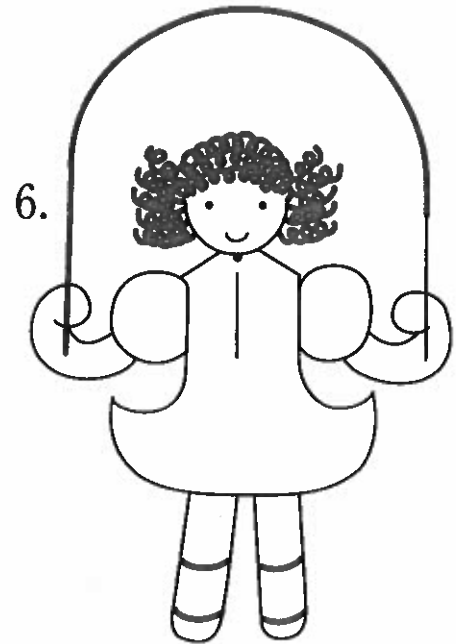
6. 

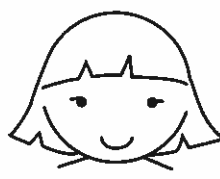
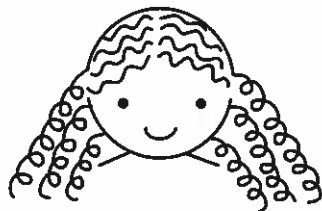

Boy

1. boy

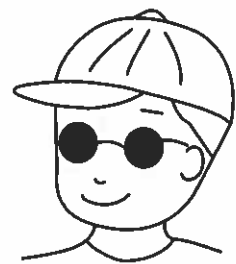
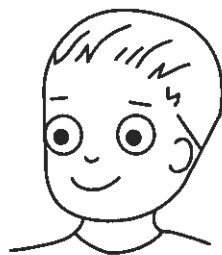
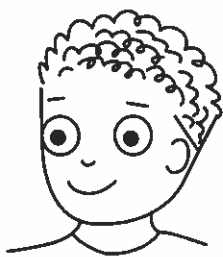
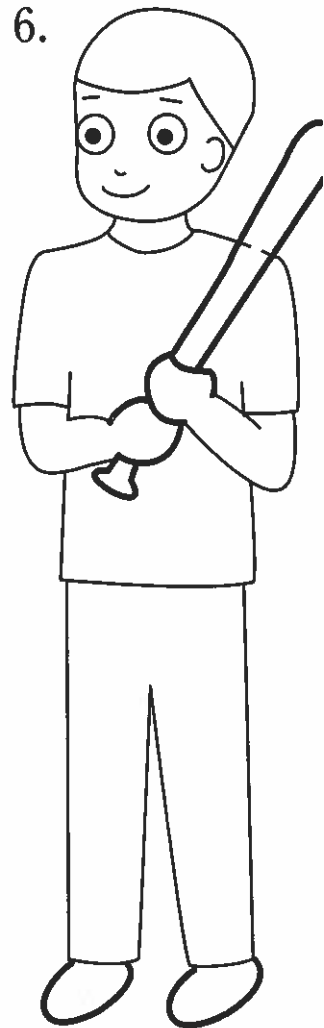
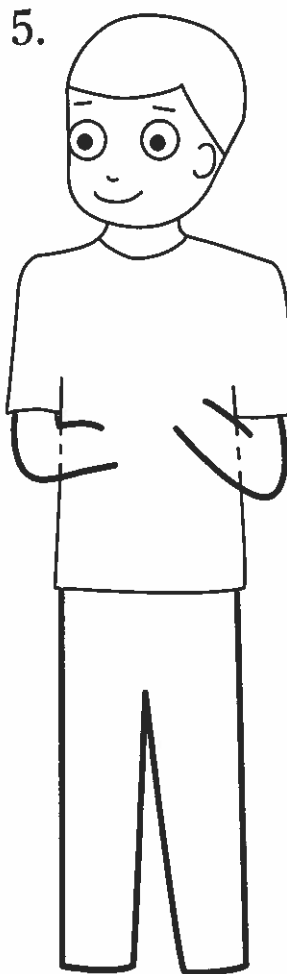
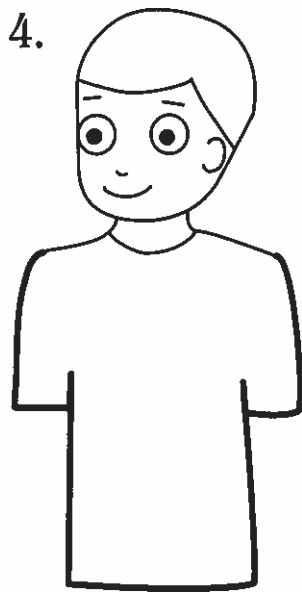
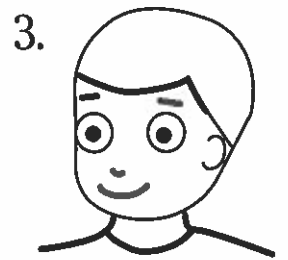
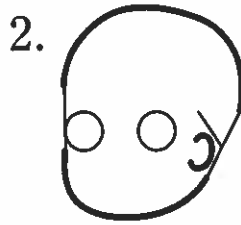

Cat

Question answered on page 50

1.

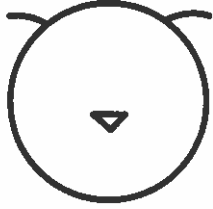

2.



3.

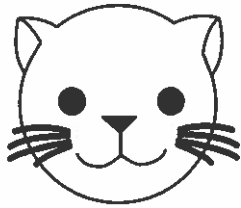

4.

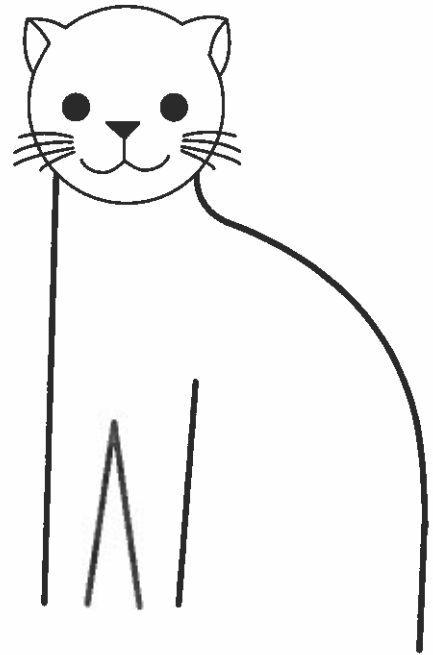

5.

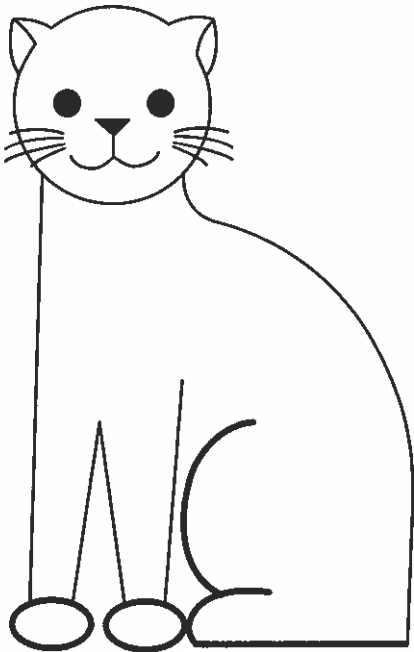

6.

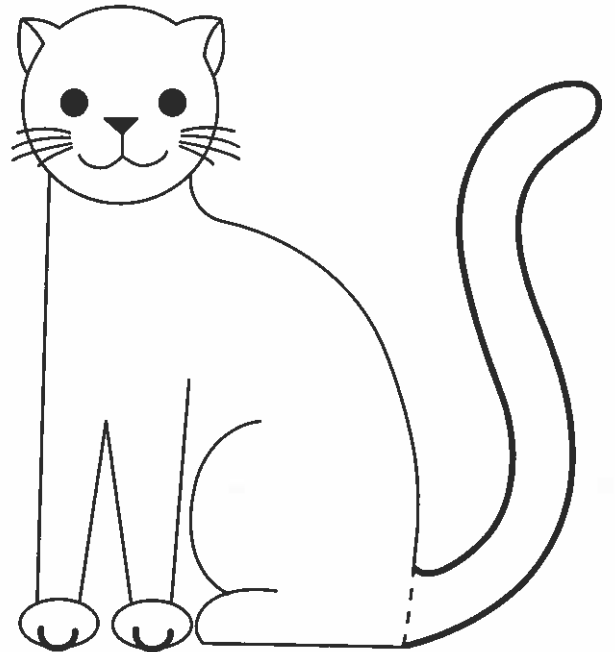

Dog

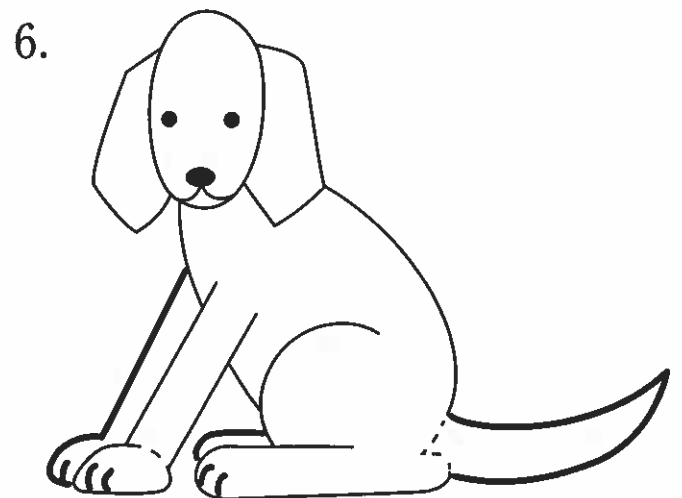
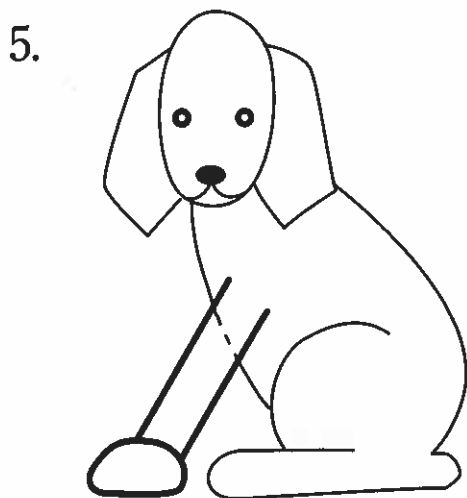
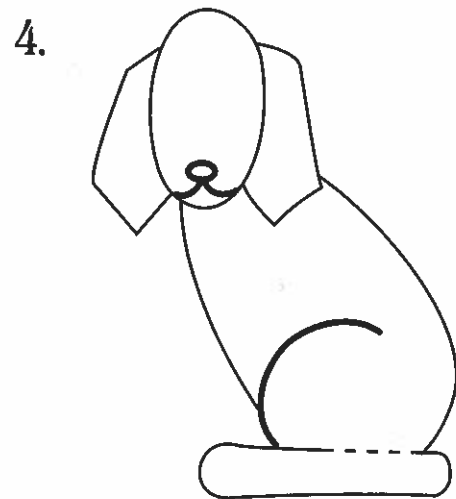
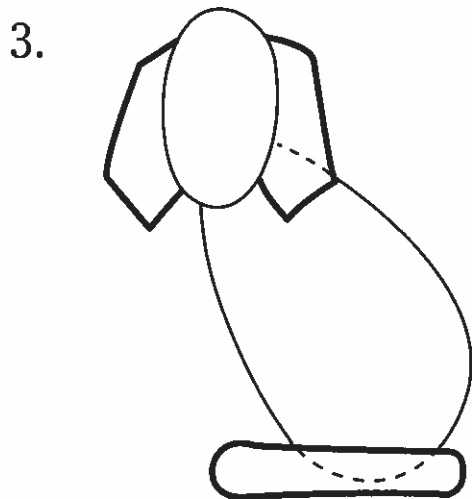
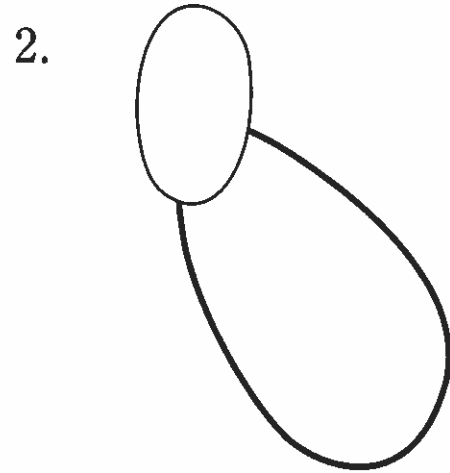
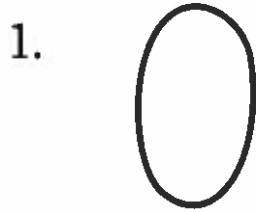

Birds

Question answered on page 50

1.

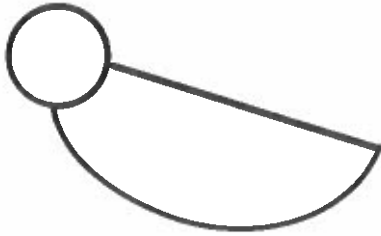

2.

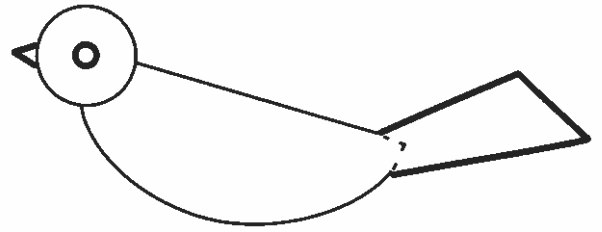

3.

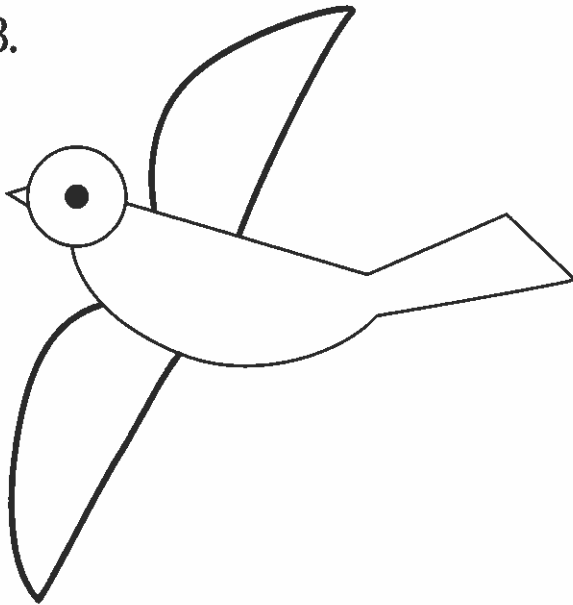

4.

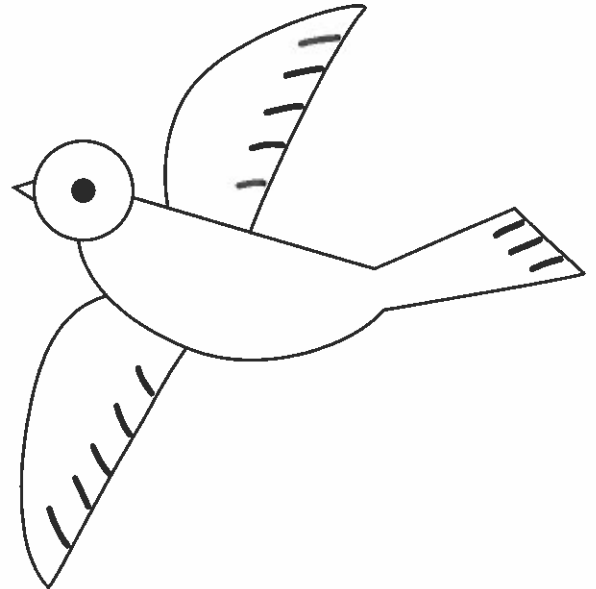

1.

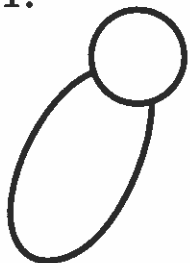

2.

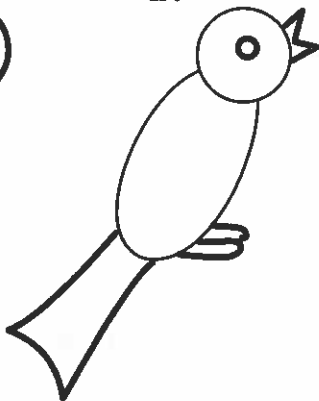

3.

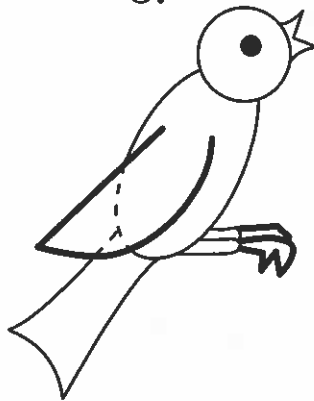

1.



2.

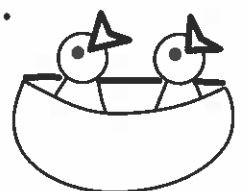

Swan

Teaching Tip on page 64

1.



2.

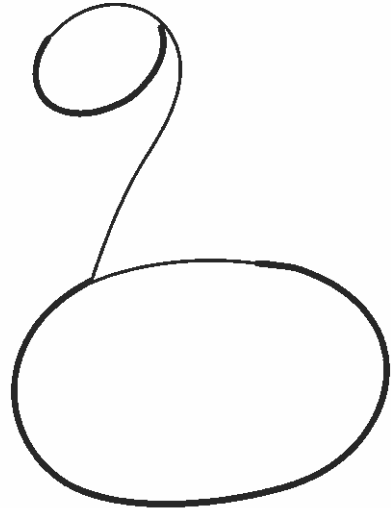

3.

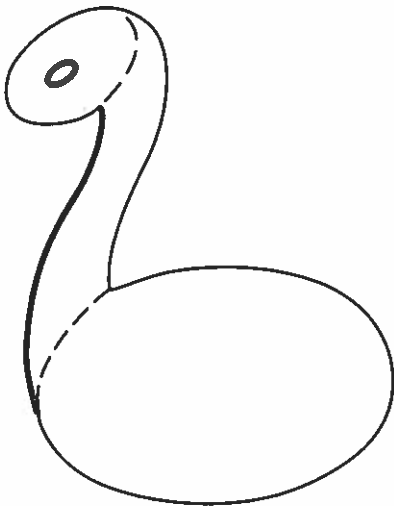

4.

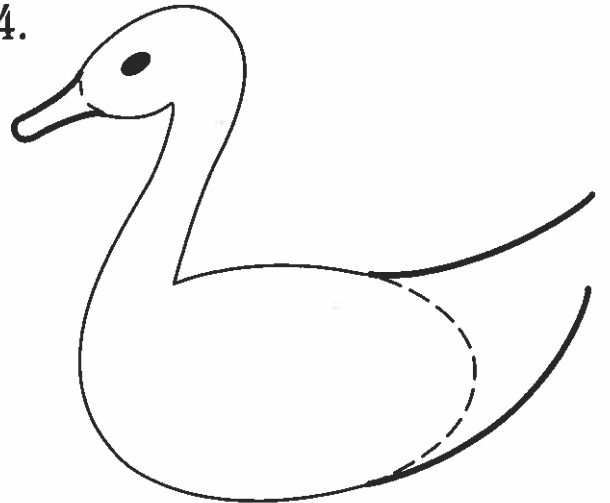

5.

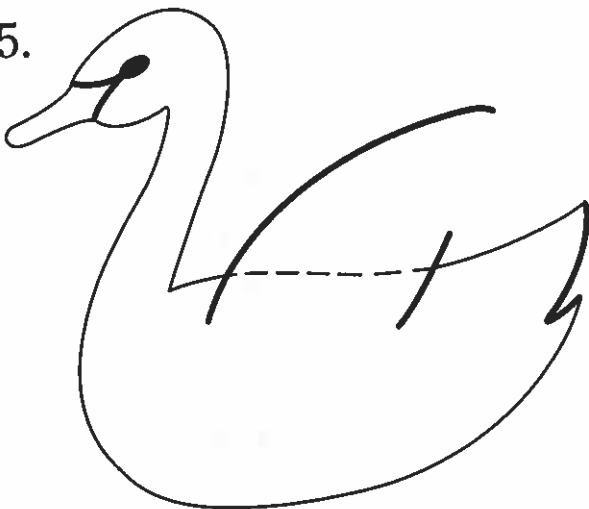

6.

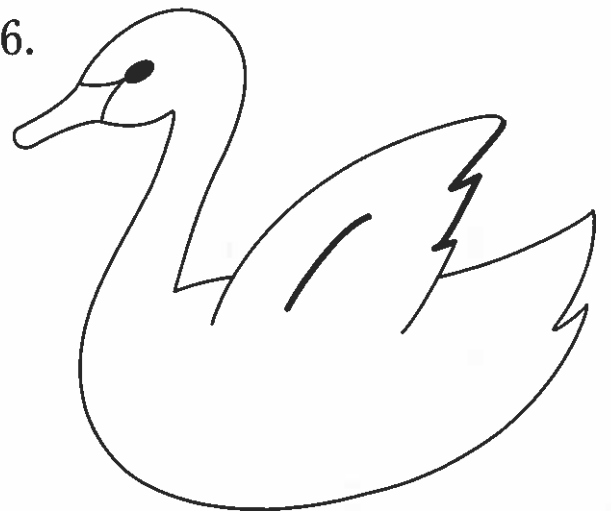

Rabbits

Question answered on page 50

1.

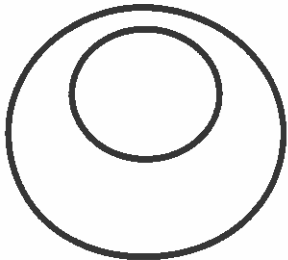

2.

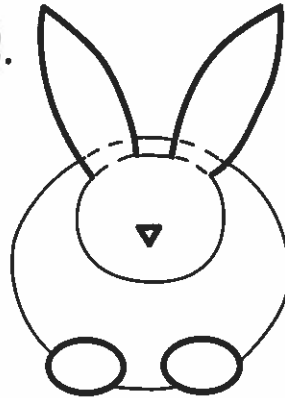

3.

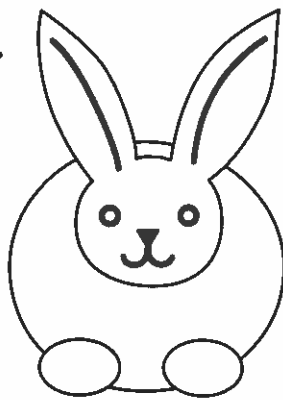

4.

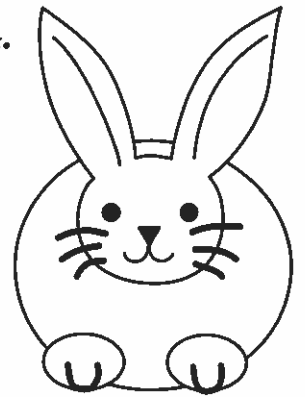

1.

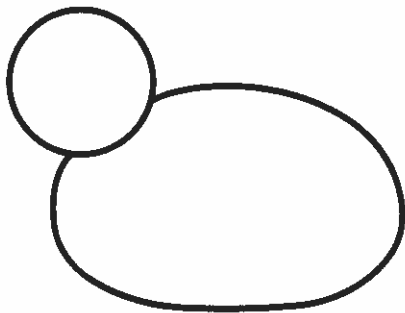

2.

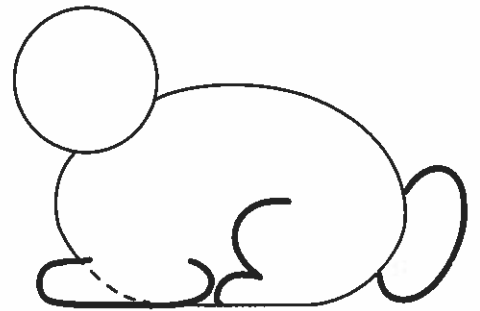

3.

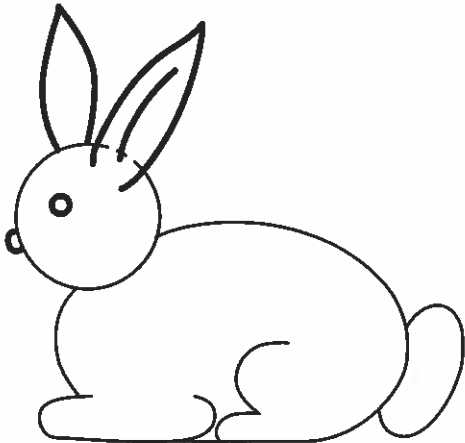

4.

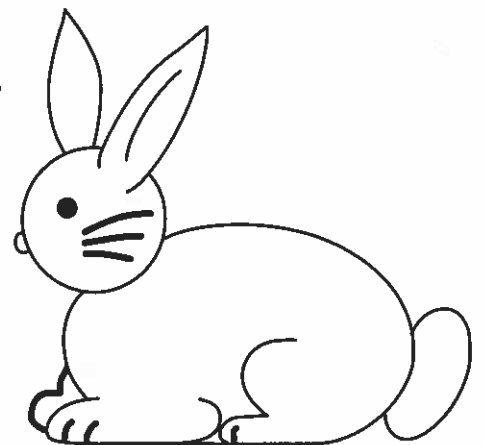

Little Red Hen

Question answered on page 62

1.

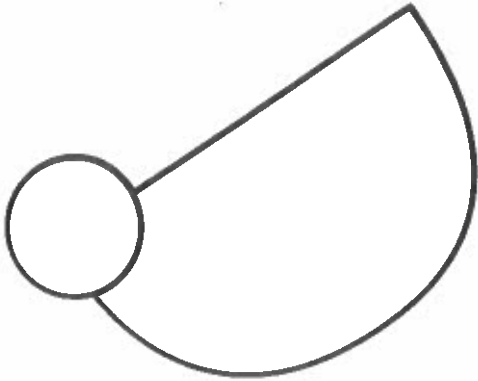

2.

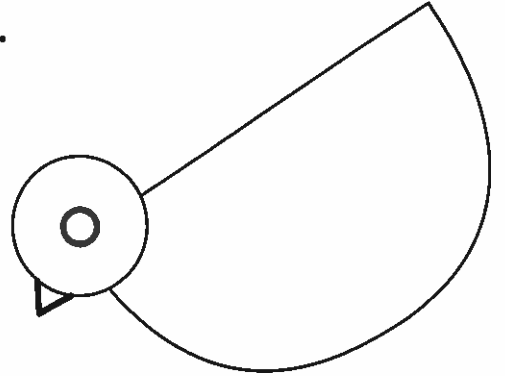

3.

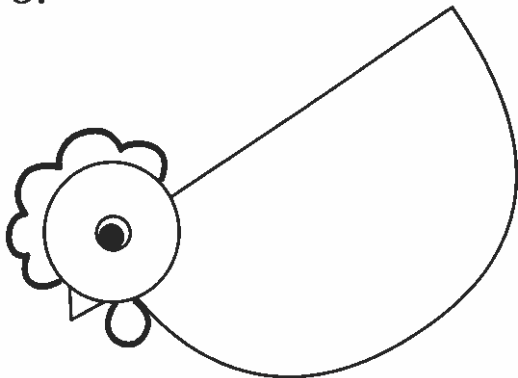

4.

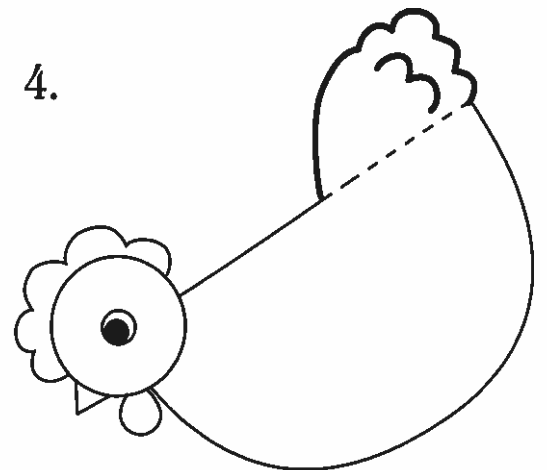

5.

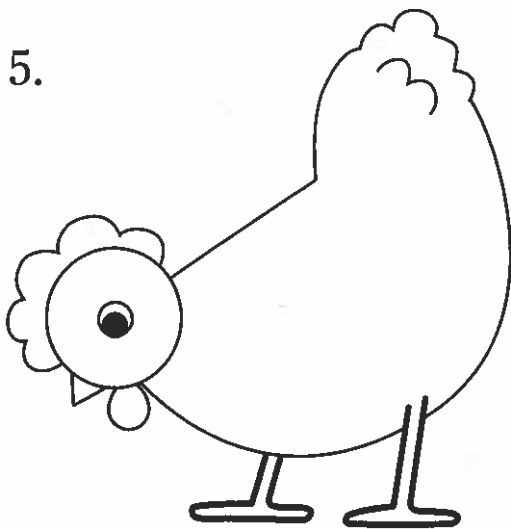

6.

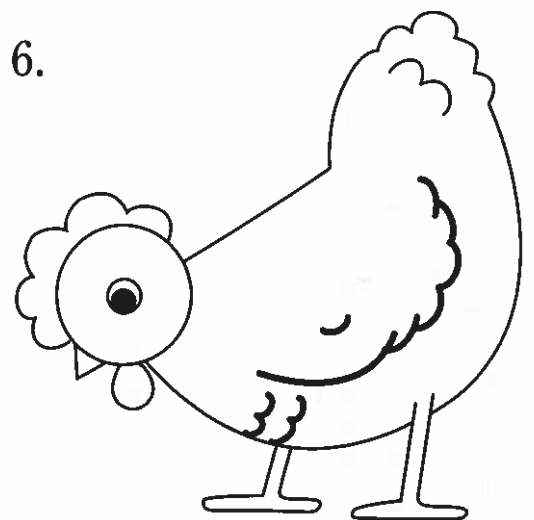

Three Little Pigs

Teaching Tip on page 64

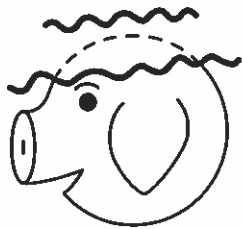
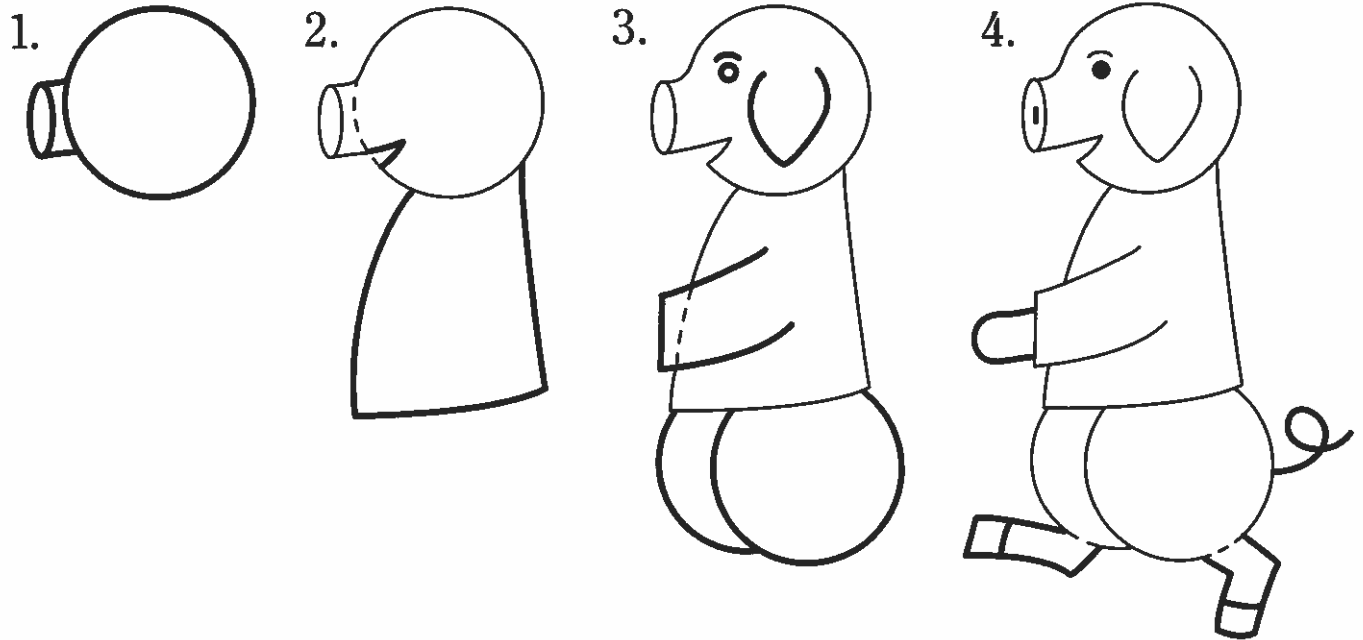

Straw Hat

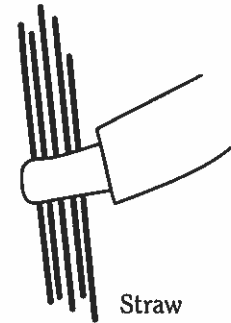
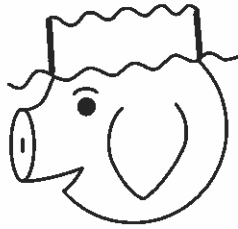

Straw

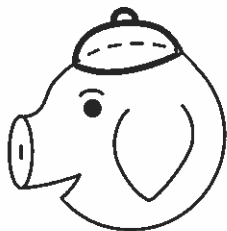

Cap

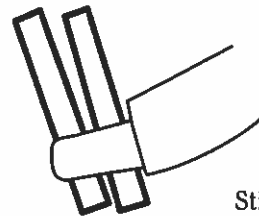
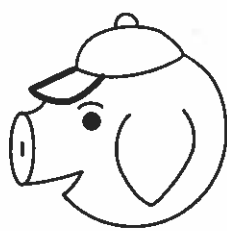

Sticks

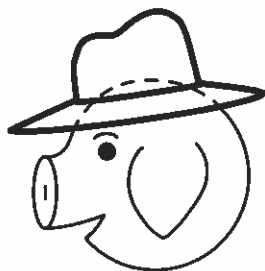
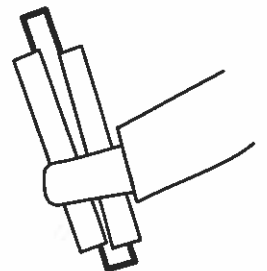

Farm Hat

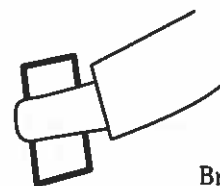
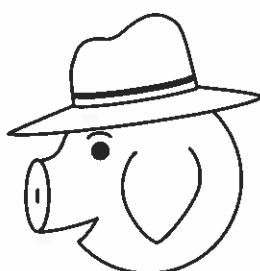

Brick

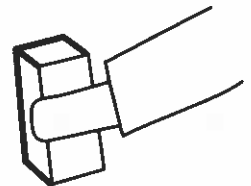

Three Bears

Teaching Tip on page 64

1.

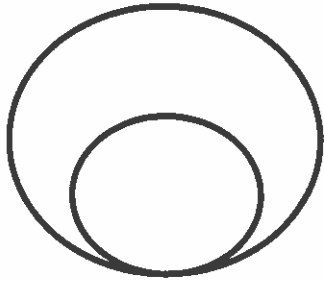

2.

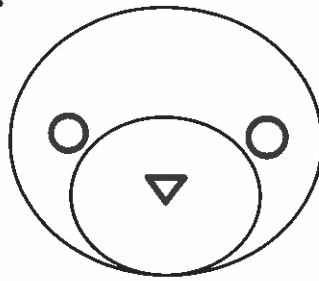

3.

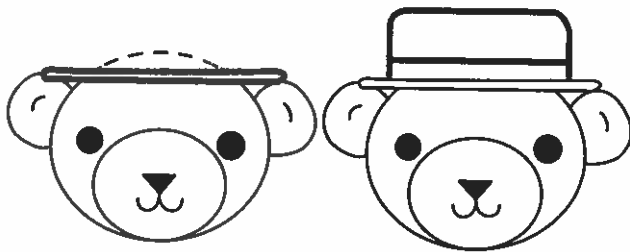
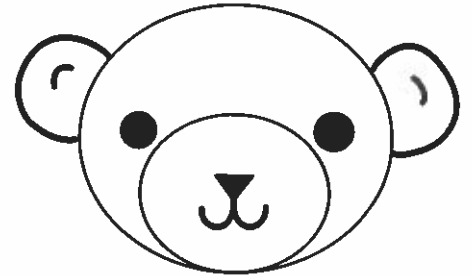

Father Bear's Hat

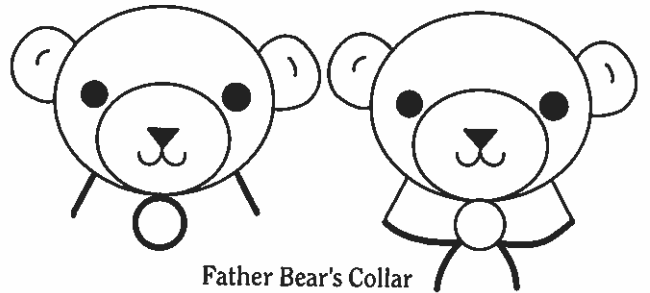

Father Bear's Collar

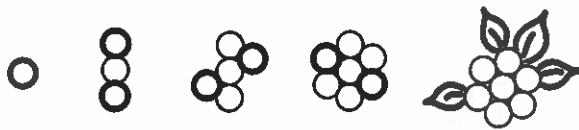
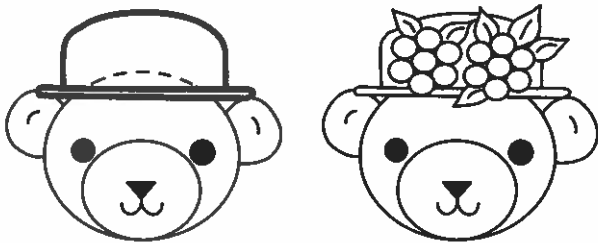

Mother Bear's Hat

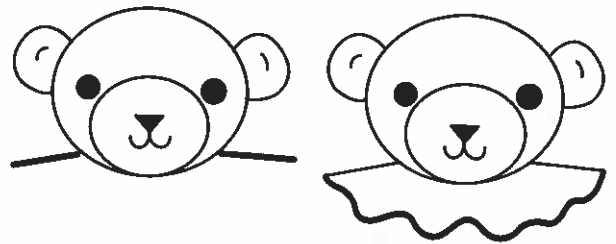

Mother Bear's Collar

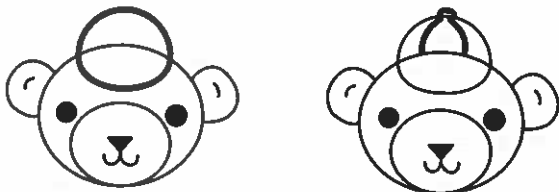

Baby Bear's Hat

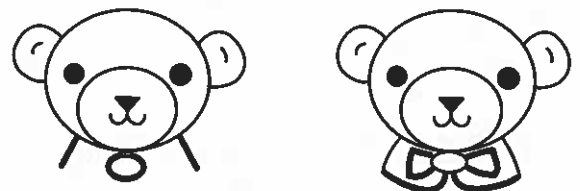

Baby Bear's Collar

Gingerbread Boy

Teaching Tip on page 64

Question answered on page 62

1.

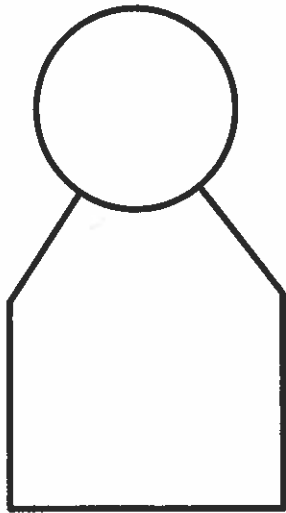

2.

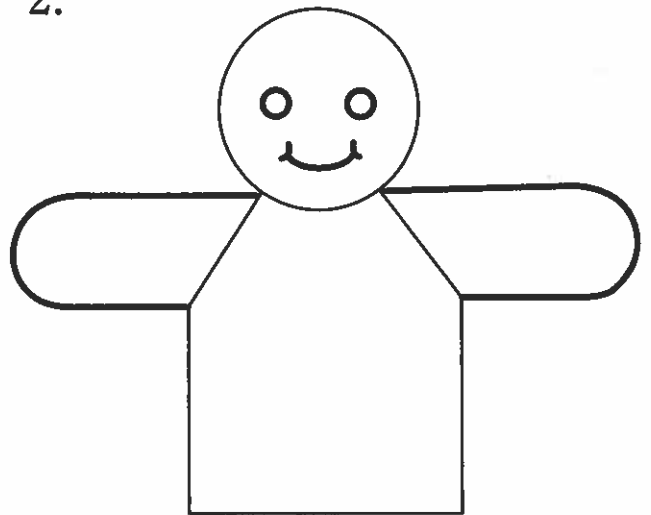

3.

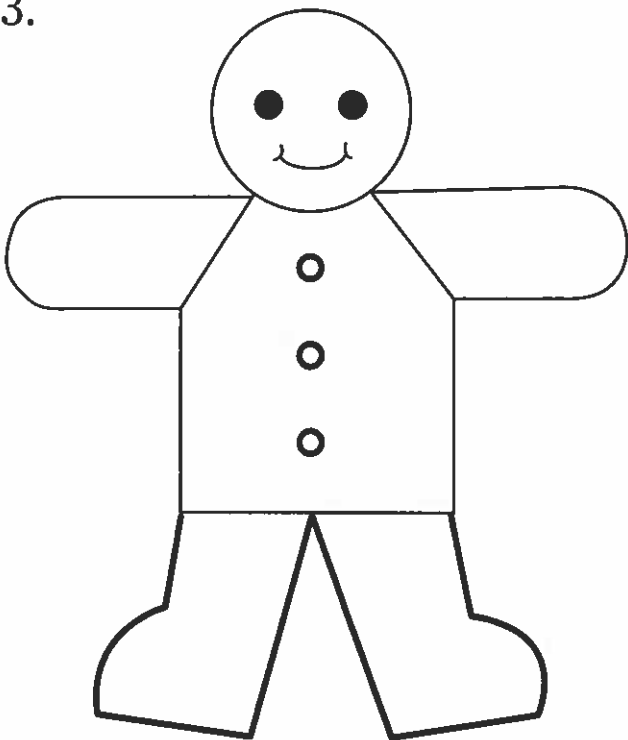

4.

